

**MITSUBISHI IGBT MODULES**  
**CM400HA-34H**  
**HIGH POWER SWITCHING USE**  
**INSULATED TYPE**

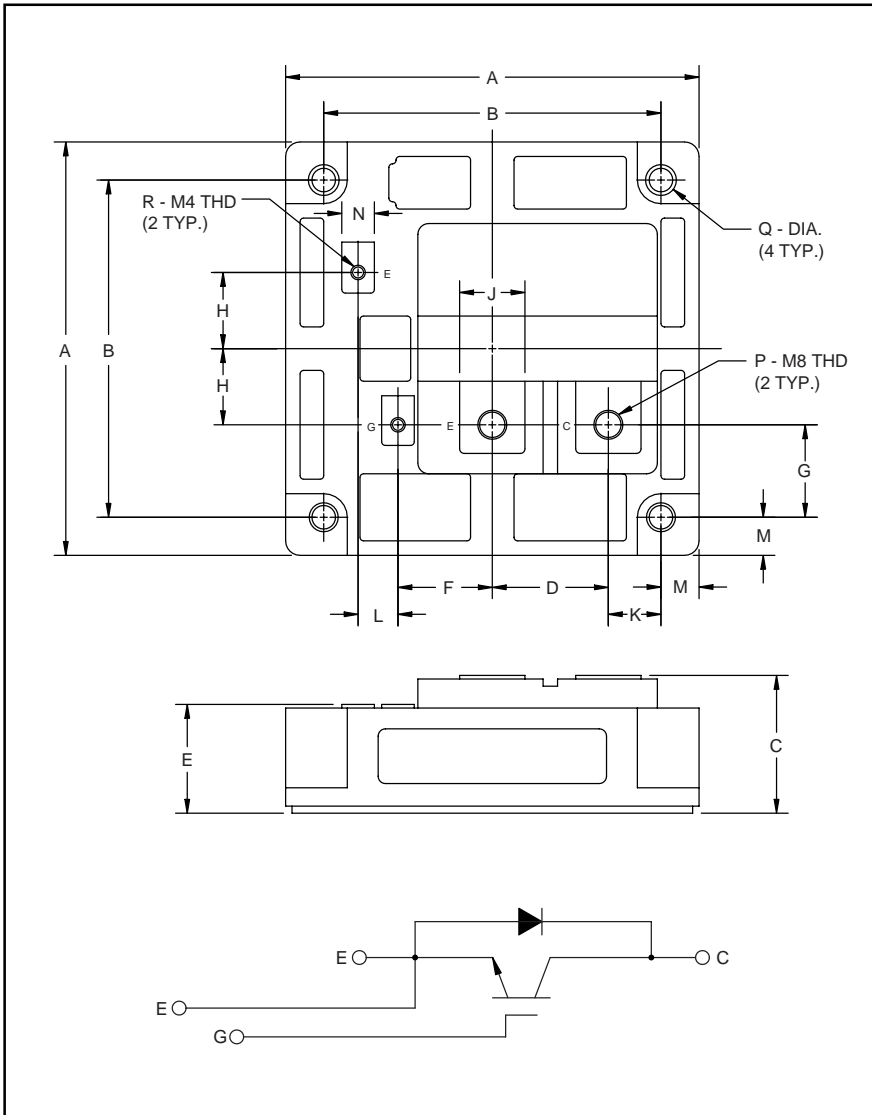

**Outline Drawing and Circuit Diagram**



**Description:**

Mitsubishi IGBT Modules are designed for use in switching applications. Each module consists of one IGBT in a single configuration with a reverse-connected super-fast recovery free-wheel diode. All components and interconnects are isolated from the heat sinking baseplate, offering simplified system assembly and thermal management.

**Features:**

- Low Drive Power
- Low  $V_{CE(sat)}$
- Discrete Super-Fast Recovery Free-Wheel Diode
- High Frequency Operation
- Isolated Baseplate for Easy Heat Sinking

**Applications:**

- AC Motor Control
- Auxilliary Inverter for Traction
- UPS
- Welding Power Supplies

**Ordering Information:**

Example: Select the complete part module number you desire from the table below -i.e. CM400HA-34H is a 1700V ( $V_{CES}$ ), 400 Ampere Single IGBT Module.

Dimensions	Inches	Millimeters
A	4.49	114.0
B	3.66±0.01	93.0±0.25
C	1.50+0.04/-0.02	38.0+1.0/-0.5
D	1.26	32.0
E	1.18+0.04/-0.02	30.0+1.0/-0.5
F	1.02	26.0
G	1.0	25.5
H	0.83	21.0

Dimensions	Inches	Millimeters
J	0.71	18.0
K	0.57	14.5
L	0.43	11.0
M	0.41	10.5
N	0.35	9.0
P	M8 Metric	M8
Q	0.26 Dia.	Dia. 6.5
R	M4 Metric	M4

Type	Current Rating Amperes	$V_{CES}$ Volts (x 50)
CM	400	34

# CM400HA-34H

HIGH POWER SWITCHING USE  
INSULATED TYPE

## Absolute Maximum Ratings, $T_j = 25\text{ }^\circ\text{C}$ unless otherwise specified

Ratings	Symbol	CM600HU-12H	Units
Junction Temperature	$T_j$	-40 to 150	$^\circ\text{C}$
Storage Temperature	$T_{stg}$	-40 to 125	$^\circ\text{C}$
Collector-Emitter Voltage (G-E SHORT)	$V_{CES}$	1700	Volts
Gate-Emitter Voltage (C-E SHORT)	$V_{GES}$	$\pm 20$	Volts
Collector Current ( $T_c = 25^\circ\text{C}$ )	$I_C$	400	Amperes
Peak Collector Current ( $T_j \leq 150^\circ\text{C}$ )	$I_{CM}$	800*	Amperes
Emitter Current** ( $T_c = 25^\circ\text{C}$ )	$I_E$	400	Amperes
Peak Emitter Current**	$I_{EM}$	800*	Amperes
Maximum Collector Dissipation ( $T_c = 25^\circ\text{C}$ )	$P_c$	4100	Watts
Mounting Torque, M8 Main Terminal	–	8.83~10.8	N · m
Mounting Torque, M6 Mounting	–	1.96~2.94	N · m
Mounting Torque, M4 Terminal	–	0.98~1.47	N · m
Weight	–	980	Grams
Isolation Voltage (Main Terminal to Baseplate, AC 1 min.)	$V_{iso}$	4000	Vrms

\* Pulse width and repetition rate should be such that the device junction temperature ( $T_j$ ) does not exceed  $T_{j(max)}$  rating.

\*\*Represents characteristics of the anti-parallel, emitter-to-collector free-wheel diode (FWDi).

## Static Electrical Characteristics, $T_j = 25\text{ }^\circ\text{C}$ unless otherwise specified

Characteristics	Symbol	Test Conditions	Min.	Typ.	Max.	Units
Collector-Cutoff Current	$I_{CES}$	$V_{CE} = V_{CES}, V_{GE} = 0V$	–	–	4	mA
Gate Leakage Current	$I_{GES}$	$V_{GE} = V_{GES}, V_{CE} = 0V$	–	–	0.5	$\mu\text{A}$
Gate-Emitter Threshold Voltage	$V_{GE(th)}$	$I_C = 40\text{mA}, V_{CE} = 10V$	4.5	6.0	7.5	Volts
Collector-Emitter Saturation Voltage	$V_{CE(sat)}$	$I_C = 400A, V_{GE} = 15V$	–	2.7	3.7**	Volts
		$I_C = 400A, V_{GE} = 15V, T_j = 150^\circ\text{C}$	–	–	–*	Volts
Total Gate Charge	$Q_G$	$V_{CC} = 750V, I_C = 400A, V_{GE} = 15V$	–	2900	–	nC
Emitter-Collector Voltage	$V_{EC}$	$I_E = 400A, V_{GE} = 0V$	–	–	3.4	Volts

\*\* Pulse width and repetition rate should be such that device junction temperature rise is negligible.

## Dynamic Electrical Characteristics, $T_j = 25\text{ }^\circ\text{C}$ unless otherwise specified

Characteristics	Symbol	Test Conditions	Min.	Typ.	Max.	Units
Input Capacitance	$C_{ies}$		–	–	85	nF
Output Capacitance	$C_{oes}$	$V_{GE} = 0V, V_{CE} = 10V$	–	–	20	nF
Reverse Transfer Capacitance	$C_{res}$		–	–	15	nF
Resistive	Turn-on Delay Time	$t_{d(on)}$	–	–	900	ns
	Rise Time	$t_r$	–	–	1500	ns
Switching	Turn-off Delay Time	$t_{d(off)}$	–	–	1500	ns
	Fall Time	$t_f$	–	–	800	ns
Diode Reverse Recovery Time	$t_{rr}$	$I_E = 400A, di_E/dt = -800A/\mu\text{s}$	–	–	400	ns
Diode Reverse Recovery Charge	$Q_{rr}$	$I_E = 400A, di_E/dt = -800A/\mu\text{s}$	–	7.0	–	$\mu\text{C}$

## Thermal and Mechanical Characteristics, $T_j = 25\text{ }^\circ\text{C}$ unless otherwise specified

Characteristics	Symbol	Test Conditions	Min.	Typ.	Max.	Units
Thermal Resistance, Junction to Case	$R_{th(j-c)}$	Per IGBT	–	–	0.030	$^\circ\text{C/W}$
Thermal Resistance, Junction to Case	$R_{th(j-c)}$	Per FWDi	–	–	0.060	$^\circ\text{C/W}$
Contact Thermal Resistance	$R_{th(c-f)}$	Per Module, Thermal Grease Applied	–	–	0.023	$^\circ\text{C/W}$

# CM400HA-34H

HIGH POWER SWITCHING USE  
INSULATED TYPE

OUTPUT CHARACTERISTICS  
(TYPICAL)

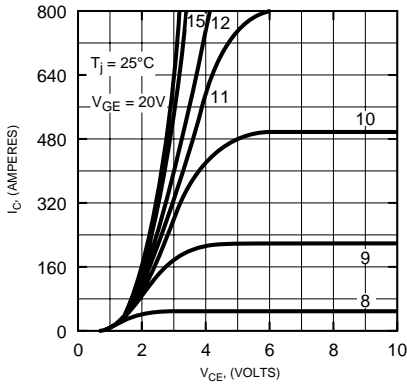

OUTPUT CHARACTERISTICS  
(TYPICAL)

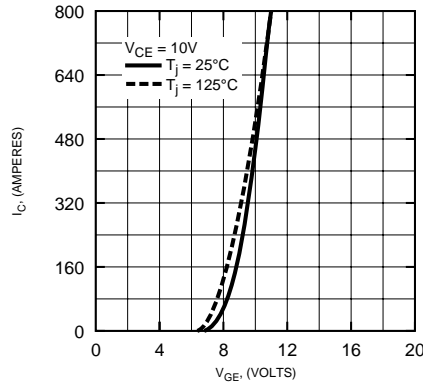

COLLECTOR-EMITTER  
SATURATION VOLTAGE CHARACTERISTICS  
(TYPICAL)

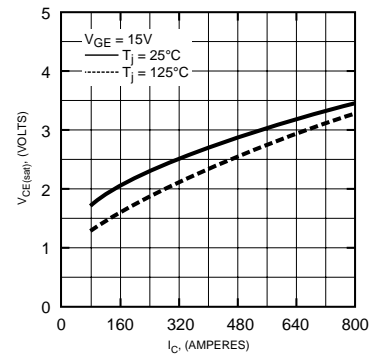

COLLECTOR-EMITTER  
SATURATION VOLTAGE CHARACTERISTICS  
(TYPICAL)

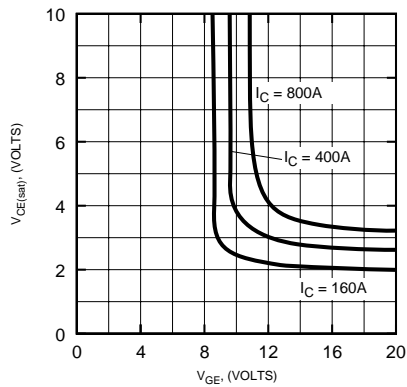

FREE-WHEEL DIODE  
FORWARD CHARACTERISTICS  
(TYPICAL)

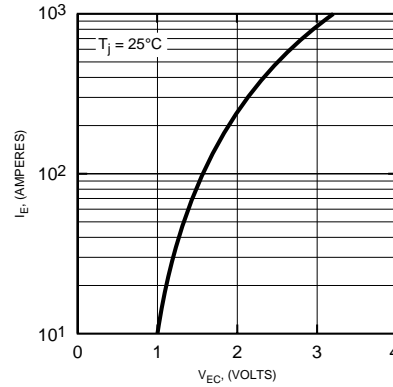

CAPACITANCE VS.  $V_{CE}$   
(TYPICAL)

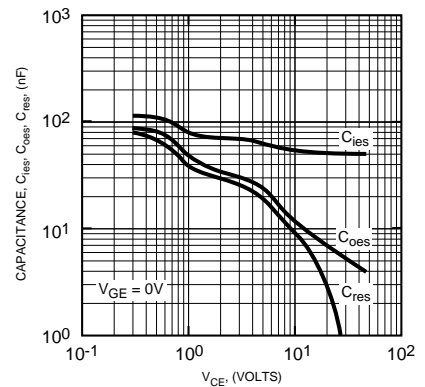

HALF-BRIDGE  
SWITCHING CHARACTERISTICS  
(TYPICAL)

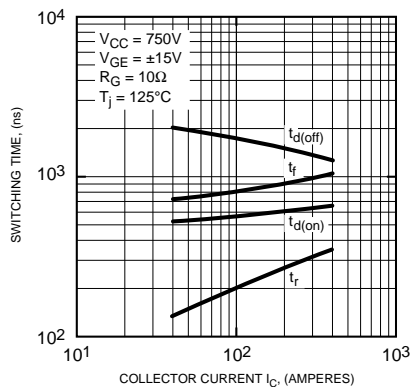

REVERSE RECOVERY CHARACTERISTICS  
(TYPICAL)

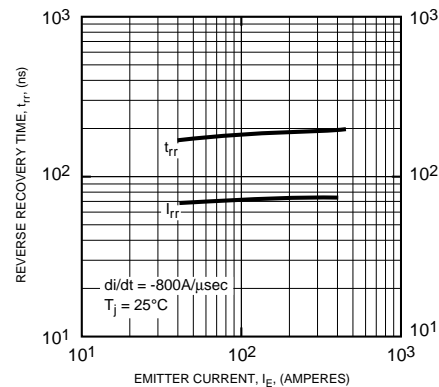

GATE CHARGE,  $V_{GE}$

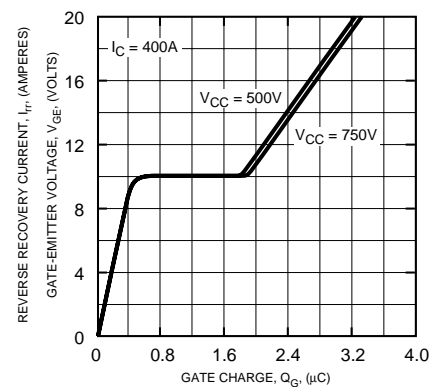

# CM400HA-34H

HIGH POWER SWITCHING USE  
INSULATED TYPE

